



Goulds 3196 *i-FRAME*[™]

Process Pump with *i-ALERT*[™]
Patented Intelligent Monitoring



ITT

ENGINEERED FOR LIFE

Proven Performance

Over One Million Process Pump Installations Worldwide

When the Goulds 3196 ANSI Standard Dimension Process Pump was first introduced in 1961, it immediately became the standard for the industry.

Today, the number of installations attest to its remarkable performance. Users in chemical, petrochemical, pulp & paper, primary metals, food & beverage and general industries know they can make no better choice than the best — Goulds Model 3196.



Before Selecting A Process Pump

Consider the Four Design Features For Extended Pump Performance

In order to select a chemical process pump wisely, consideration must be given to design features that provide long-term reliable performance. The pump must be designed for optimum shaft seal and bearing life to prevent the failure of these two primary causes of pump downtime.

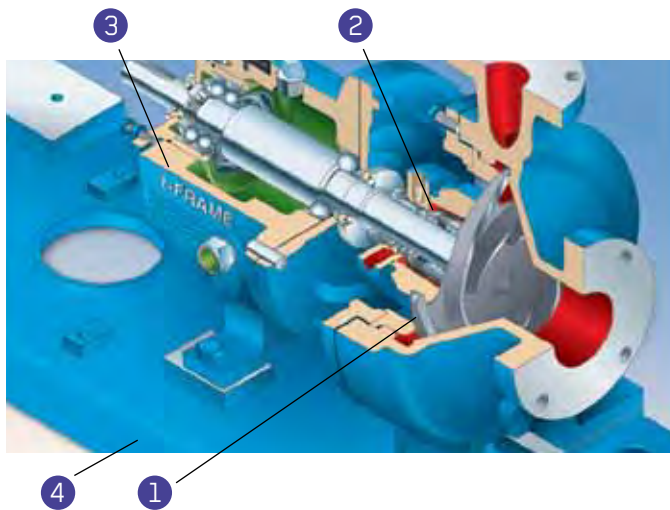

- 1 Impeller**
Must be designed for long-term, maintainable performance and minimum hydraulic loads for maximum reliability.
- 2 Seal Chamber**
Must be designed for favorable seal environment — proper heat dissipation and lubrication of seal faces. The design must also be able to handle tough services: liquids containing solids, air or vapors.
- 3 Power End**
Must be designed for optimum bearing life, effective oil cooling, and minimum shaft deflection. Onboard condition monitoring provides early warning of potential failures, before they occur.
- 4 Baseplate**
Must be rigid, and able to withstand forces and moments of plant piping systems.

FULLY OPEN IMPELLER

Best design for the Chemical Process Industries services. Ideally suited for corrosives and abrasives, handles solids and stringy fibers with ease. Allows for simple restoration of clearances when wear takes place. Back pump-out vanes reduce pressure on the shaft seal, reduce axial thrust on the bearings.



ENGINEERED SEAL CHAMBERS

BigBore™ and patented TaperBore™ PLUS seal chambers allow seals to run cooler with better face lubrication. Keep solids, air and vapors away from the seal faces for extended seal life.



i-FRAME™ POWER ENDS

Patented design maximizes reliability and Mean Time Between Failure (MTBF). Severe-duty bearings increase bearing life 2-5 times, while onboard condition monitor gives visible indication of general pump health. Backed by a five-year standard warranty.

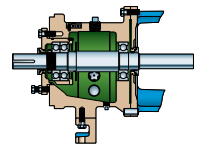

PUMP MOUNTING SYSTEM

Critical for reliability ... rigid baseplate prevents distortion, maintaining pump/motor alignment; corrosion resistant in severe environments. Designed for low vibration and to withstand pipe loads. Meets total range of plant requirements, easier installation and maintenance.

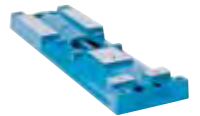

Consider the Total Cost of Ownership

Consider the fact that over a 20-year ANSI pump life, 92% of the total costs are maintenance, operation and installation. Only 8% is the initial pump purchase cost. Select a process pump that maximizes reliability (low maintenance cost), has long-term maintainable hydraulic performance (low operating cost) and is installed on a rigid baseplate. Energy and maintenance costs during the life of a process pump can be more than 10 times its purchase price.

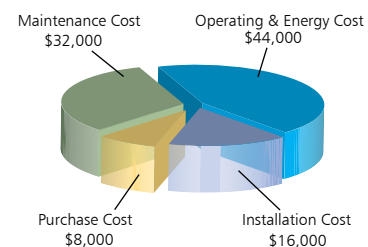

Fully Open Impeller

Acknowledged Best Design for CPI Services

The open impeller is the acknowledged best design for process services. It is ideally suited for corrosive/erosive liquids containing solids and stringy materials. The most reliable pumps feature open impellers as standard.



See The Difference

Remarkably, Goulds had performance in mind when the Model 3196 standard dimension process pump was developed in 1959. Of timely significance was the decision to feature a fully open impeller rather than an enclosed type. There are three excellent reasons why:

- Greater wear area for longer life
- Renewable performance for reduced repair costs
- Minimum hydraulic loads for maximum mechanical reliability



Open Impeller Enclosed-type Impeller

1. Two Times More Wear Area

Longer Life, Reduced Repair Costs

The most critical wear areas of a pump are the casing and stuffing box/seal chamber clearances. At a given wear rate, the larger wear area means longer life.

Open Impeller

Wear is uniform throughout larger area; no concentrated wear... extended life, reduced repair part cost.

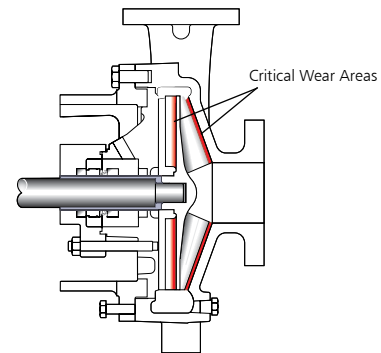

Wear Area Calculation (10 inch dia. impeller)

$$\text{Area Wear Surface} = \pi r^2 = \pi(5)^2 = 79 \text{ in}^2$$

$$\text{Total Wear Area (Front \& Back)} = 2 \times 79 = 158 \text{ in}^2$$

Enclosed Type Impeller

Less wear area with concentrated wear at nose of impeller ... higher repair part cost.

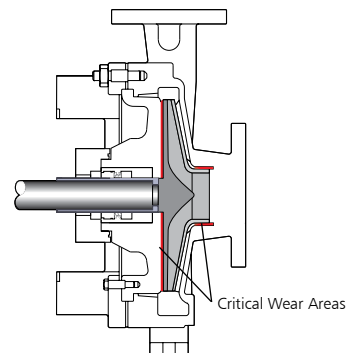

$$\text{Area Nose Ring} = 2\pi rW = 2\pi(5)(.9) = 5 \text{ in}^2$$

$$\text{Area Back Cover} = \pi r^2 = \pi(5)^2 = 79 \text{ in}^2$$

$$\text{Total Wear Area} = 5 + 79 = 84 \text{ in}^2$$

2. Maintained High-Performance

Long Pump Life

It is common knowledge that as a pump wears, the performance decreases. Goulds open impeller can be adjusted, simply and quickly, to compensate for wear and renew performance. The enclosed type impeller cannot be adjusted. Performance renewal requires new or repaired casing and impeller.

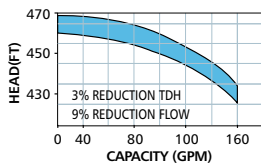
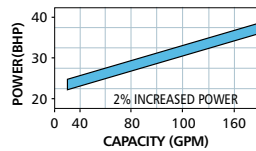
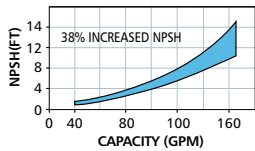

Typical reduction in performance due to wear (.010 inch per year) on any ANSI pump.

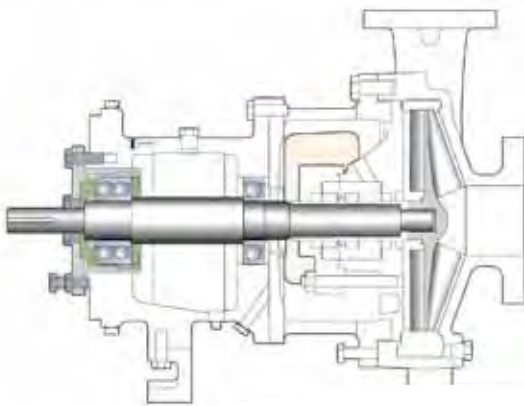

Open Impeller

Original performance can be re-set (at the bench or on-site) with external impeller adjustment using a common open-end wrench and feeler gauge. *It is done in a matter of minutes.*

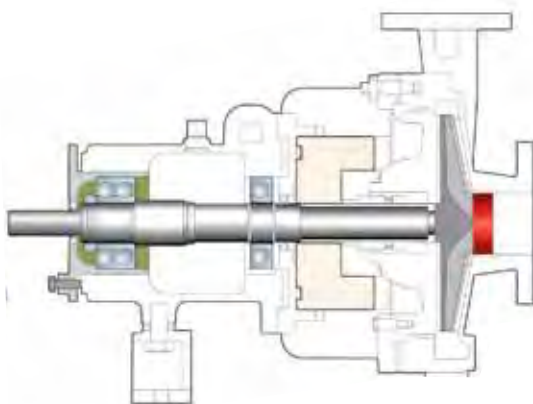

Enclosed Type Impeller

Front nose ring of impeller cannot be adjusted to provide 'as new' performance. Parts must be replaced or repaired.

3. Minimum Hydraulic Loads

Extended Seal and Bearing Life

Goulds open impeller is engineered to assure minimum radial and axial thrust loads; controlled clearances between front and back of impeller minimize radial loads; back pump-out vanes control and reduce axial thrust. Bearing life is guaranteed.

Engineered For Long Life

Back vane height/angle and shroud design are engineered to minimize hydraulic loads throughout the life of the pump. Bearing life is guaranteed.

As the open impeller is adjusted and performance renewed, back pump-out vanes control axial thrust.

Bearing and seal life are maintained — unaffected by adjustment.

- Control Axial Thrust
- Low Radial Loads
- Control Seal Chamber Pressure
- Guaranteed Bearing Life
- Extended Seal Life

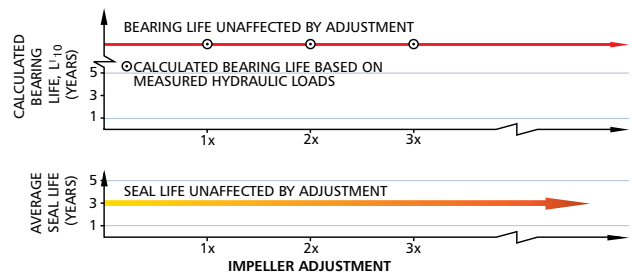
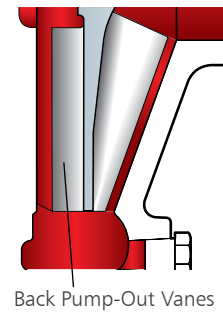

Goulds Engineered Seal Chambers

Extend Seal Life And Lower Maintenance Costs





Seal Environment is Critical for Extended Seal Life

The number one cause of pump downtime is failure of the shaft seal. These failures are normally the result of an unfavorable seal environment such as improper heat dissipation (cooling), poor lubrication of the seal faces, or seals operating in liquids containing solids, air or vapors.

Goulds engineered seal chambers are designed to provide the best seal environment for any sealing arrangement.

Enlarged bore seal chambers (BigBore™ and patented TaperBore™ PLUS) with increased radial clearance between the mechanical seal and seal chamber provide better circulation of liquid to and from seal faces. Improved lubrication and heat removal extend seal life and pump uptime. The bottom line is lower maintenance costs.

Engineered Seal Chamber Selection Guide

A Ideally suited	B Acceptable	C Not Recommended	Service												
			Water-Based Liquids with Flush	Entrained Air or Vapor	Solids 0-10%, no Flush	Solids Greater than 10% with Flush	Paper Stock 0-5%, no Flush	Paper Stock 0-5%, with Flush	Slurries 0-5%, no Flush	High Boiling Point Liquids, no Flush	Temperature Control	Self-Venting and Draining	Seal Face Heat Removal	Molten or Polymerized Liquid, no Flush	Molten or Polymerized Liquid with Flush
	Standard Bore Designed for packing. Also accommodates mechanical seals.	A	C	C	B	C	B	C	C	C	C	C	C	C	
	BigBore™ Enlarged chamber for increased seal life through improved lubrication and cooling.	A	B	C	A	C	A	C	C	C	B	A	C	C	
	Patented TaperBore™ PLUS Lower seal face temperatures, self-venting and draining. Solids and vapors circulated away from seal faces.	A	A	A	C	A	—	A	A	C	A	A	C	C	
	Jacketed Patented TaperBore™ PLUS Maintains proper temperature control (heating or cooling) of seal environment.	A	A	A	C	—	—	A	A	A	A	A	A	A	
	Jacketed BigBore™ Maintains proper temperature control (heating or cooling) of seal environment.	A	B	C	A	—	—	C	C	A	C	A	A	A	

Goulds 3196 *i-FRAME*TM

Goulds Dynamic Seal

Eliminate Sealing Problems, Reduce Maintenance Costs

On tough pumping services, especially corrosives and slurries, mechanical seals require outside flush and constant, costly attention. Even then, seal failures are common, resulting in downtime.

Goulds offers a solution: The Dynamic Seal which, simply by fitting a repeller between the stuffing box cover and impeller, eliminates the need for a mechanical seal.

Benefits of Dynamic Seal:

- Eliminate use of seal water
- Eliminate pumpage contamination and product dilution
- Reduce utility cost
- Eliminate problems associated with piping from a remote source
- Eliminate need to treat seal water
- Considerably less expensive than a slurry mechanical seal



Stuffing Box Cover



Repeller



Repeller Plate

Besides being available as a complete unit, any Goulds 3196 can be easily field-converted to Dynamic Seal. Retrofit kits are available.

Sealless Solutions

Not all process pump applications can be sealed with optimum reliability. Goulds ANSI dimensional magnetic drive sealless process pumps are perfect solutions to mechanical seal or environmental sealing problems. The 3296 EZMAG metal magnetic drive process pump has a revolutionary bearing cartridge design for maximum reliability and ease of maintenance. For tough corrosive services Goulds also offers ETFE[®] and PFA-lined magnetic drives available in horizontal, vertical or self-priming configurations to meet all your process needs.



Goulds Patented* TaperBoreTM PLUS

How it Works

The unique flow path created by the patented Vane Particle Ejector directs solids away from the mechanical seal, not towards the seal as with other tapered bore designs. And, the amount of solids entering the bore is minimized. Air and vapors are also efficiently removed.

On services with or without solids, air or vapors, Goulds patented TaperBoreTM PLUS is the effective solution for extended seal and pump life and lower maintenance costs.

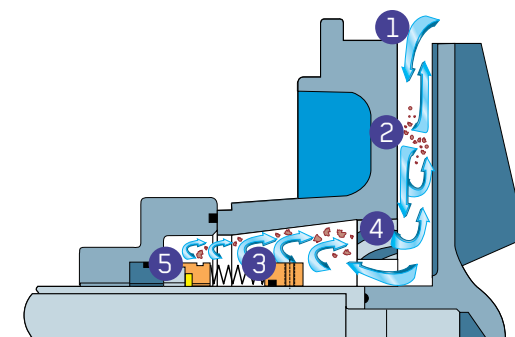

*U.S. Patent No. 5,336,048

- 1 Solids/liquid mixture flows toward mechanical seal / seal chamber.
- 2 Turbulent zone. Some solids continue to flow toward shaft. Other solids are forced back out by centrifugal force (generated by back pump-out vanes).
- 3 Clear liquid continues to move toward mechanical seal faces. Solids, air, vapors flow away from seal.
- 4 Enhanced streamline created by Vane Particle Ejector. Solids, air, vapor liquid mixture exit seal chamber bore.
- 5 Flow in patented TaperBoreTM PLUS seal chamber assures efficient heat removal (cooling) and lubrication. Seal face heat is dissipated. Seal faces are continuously flushed with clean liquid.

Goulds Patented *i-FRAME*[™] Power Ends

Extended Pump Life Through Intelligent Design

Goulds i-Frame Power Ends are the result of 160 years of design experience, customer interaction, and continuous improvement. Customers get extended Mean Time Between Failure (MTBF) and lower life cycle costs (LCC) ... guaranteed!

1 Patented *i-ALERT*[™] Condition Monitor



The heart of the i-Frame, the i-ALERT condition monitor unit continuously measures vibration and temperature at the thrust bearing and automatically

indicates when pre-set levels of vibration and temperature have been exceeded, so that changes to the process or machine can be made before failure occurs. A visual indication of pump health makes walk-around inspections more efficient and accurate. The result is a more robust process to monitor and maintain all your ANSI pumps so that your plant profitability is maximized.

2 Inpro VBXX-D Hybrid Bearing Isolators

Most bearings fail before reaching their potential life. They fail for a variety of reasons, including contamination of the lubricant. INPRO VBXX-D has long been considered the industry standard in bearing lubricant protection. The i-FRAME now improves upon that design by offering stainless steel rotors, for maximum protection against contaminants and the corrosive effects of seal leakage or environmental conditions. These seals are non-contacting and do not wear.

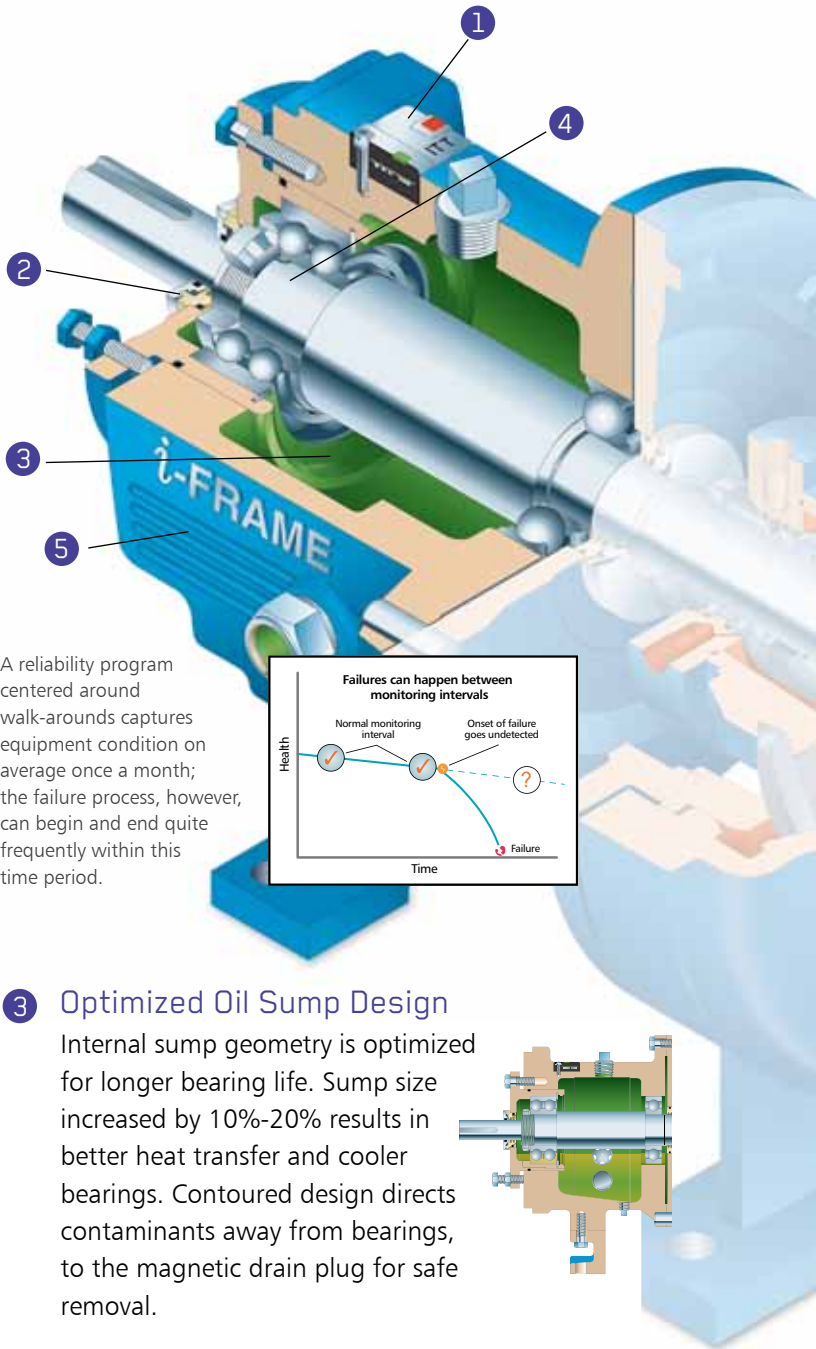
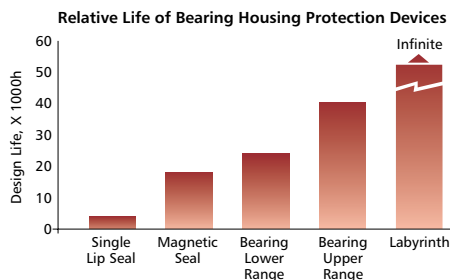

A reliability program centered around walk-arounds captures equipment condition on average once a month; the failure process, however, can begin and end quite frequently within this time period.

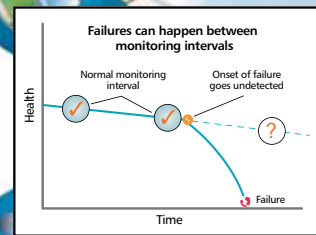

3 Optimized Oil Sump Design

Internal sump geometry is optimized for longer bearing life. Sump size increased by 10%-20% results in better heat transfer and cooler bearings. Contoured design directs contaminants away from bearings, to the magnetic drain plug for safe removal.

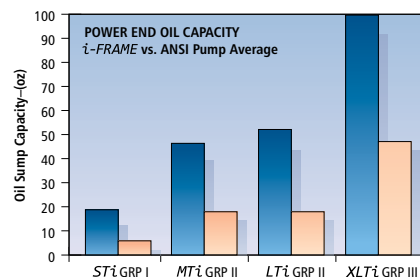
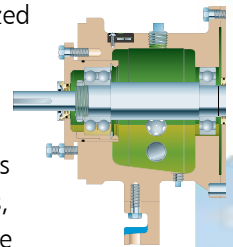

Larger Means Cooler
■ GOULDS
■ Industry Average

4 Shaft and Bearings Engineered for Maximum Reliability

Every 3196 i-Frame Power End is engineered and manufactured for optimal pump performance and increased MTBF.

ANSI B73.1 Shaft Specification	Meets	Exceeds
Diameter Tolerance		✓
Surface Finish		✓
Runout	✓	
Deflection		✓

The rugged shaft and bearing combination maintains shaft deflection of less than 0.002 inches at all operating points. The result is longer seal and bearing life.

Premium severe-duty thrust bearings increase bearing fatigue life.

- High purity steels have fewer inclusions than standard steel – better grain structure and wear resistance.
- Heat treatment of bearing elements to SO stabilization levels provides superior thermal stability for increased service life.
- Bearing Balls are manufactured to at least one ISO grade above standard (ISO P5 for ring running accuracy and ISO P6 for dimensions). The result is reduced vibration and noise for improved shaft guidance.

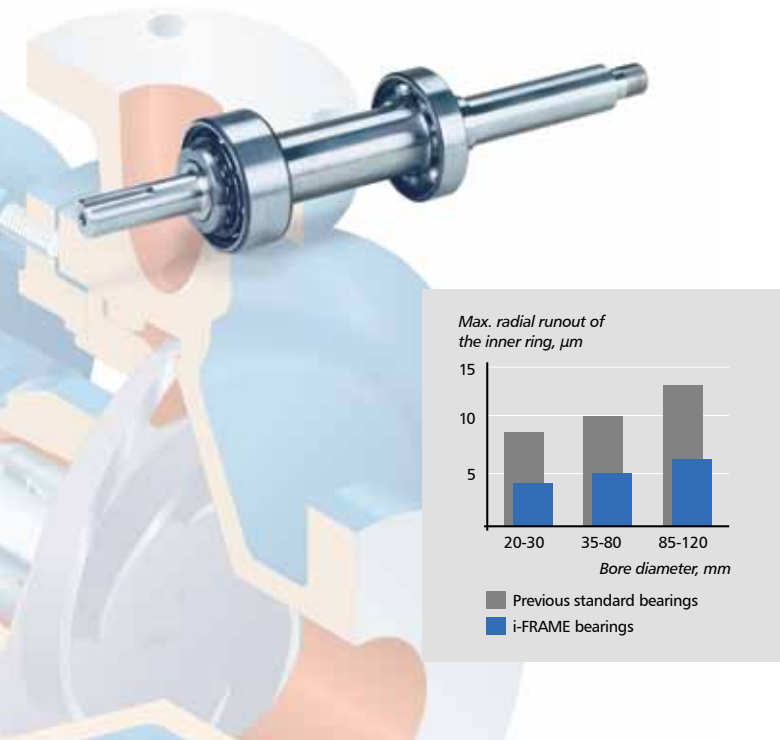

5 *LTi* Power End for High Load Applications Increased L'10 Bearing Life 150% to 200% on the Toughest Applications

Ideal for tough conditions when a power end is pushed beyond ANSI limits; operating at low flows and higher heads, pumping high specific gravity liquids, fluctuating process conditions, overhung belt drive.

Oversized shaft and bearing assembly significantly expands the limits for long, trouble-free bearing and seal life. On high load applications, the *LTi* power end improves bearing life 150% - 200%; oil operating temperature reduced by 45°F (25°C).

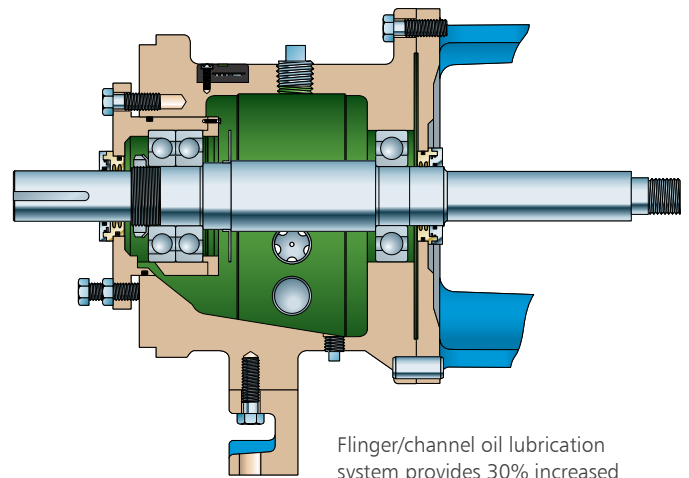

Flinger/channel oil lubrication system provides 30% increased L'10 life; 15°F (8°C) reduced oil temperature.



Duplex thrust bearings (40°/40° angular contact) with machined brass cages, are ideally sized for high load applications.



Oversized shaft with duplex thrust bearings provide increased L'10 by 40%.

Our Guarantee

We are so confident that the i-FRAME is the most reliable Power End in the industry, that we are proud to offer a standard 5-year warranty on every i-FRAME ANSI Process Pump.



3196 *i-FRAME*[™] Process Pumps

Featuring *i-ALERT*[™] Patented Monitoring

i-ALERT[™] CONDITION MONITOR (Patent Pending)

Constantly measures vibration and temperature at the thrust bearing. Colored LED's indicate general pump health. Provides early warning of improper operation before catastrophic failure occurs.

INPRO VBXX-D HYBRID LABYRINTH SEALS

Prevents premature bearing failure caused by lubricant contamination or loss of oil. Stainless steel rotors for optimal performance in corrosive environments.

CONTINUOUS PERFORMANCE

Original flow, pressure and efficiency are maintained by simple external adjustment resulting in long-term energy and repair parts savings.

PREMIUM SEVERE-DUTY THRUST BEARINGS

Premium bearings using improved tolerances and cleaner steel provide reduced assembled runout and longer bearing life.

HEAVY DUTY SHAFT AND BEARINGS

Rigid shaft designed for minimum deflection at seal faces—less than 0.002 in. (.05 mm). Bearings sized for 10-year average life under tough operating conditions. Available with or without shaft sleeve.

OPTIMIZED OIL SUMP DESIGN

Increased oil capacity provides better heat transfer for reduced oil temperature. Bearings run cooler and last longer. Contaminants directed away from bearings to magnetic drain plug.

ONE - INCH BULL'S EYE SIGHT GLASS

Assures proper oil level critical to bearing life. Can be mounted on either side of pump for installation flexibility.

i-FRAME[™] POWER END

Designed for reliability and extended pump life, backed with a 5-year warranty.

MAGNETIC DRAIN PLUG

Standard magnetic drain plug helps protect bearings and prolong life.

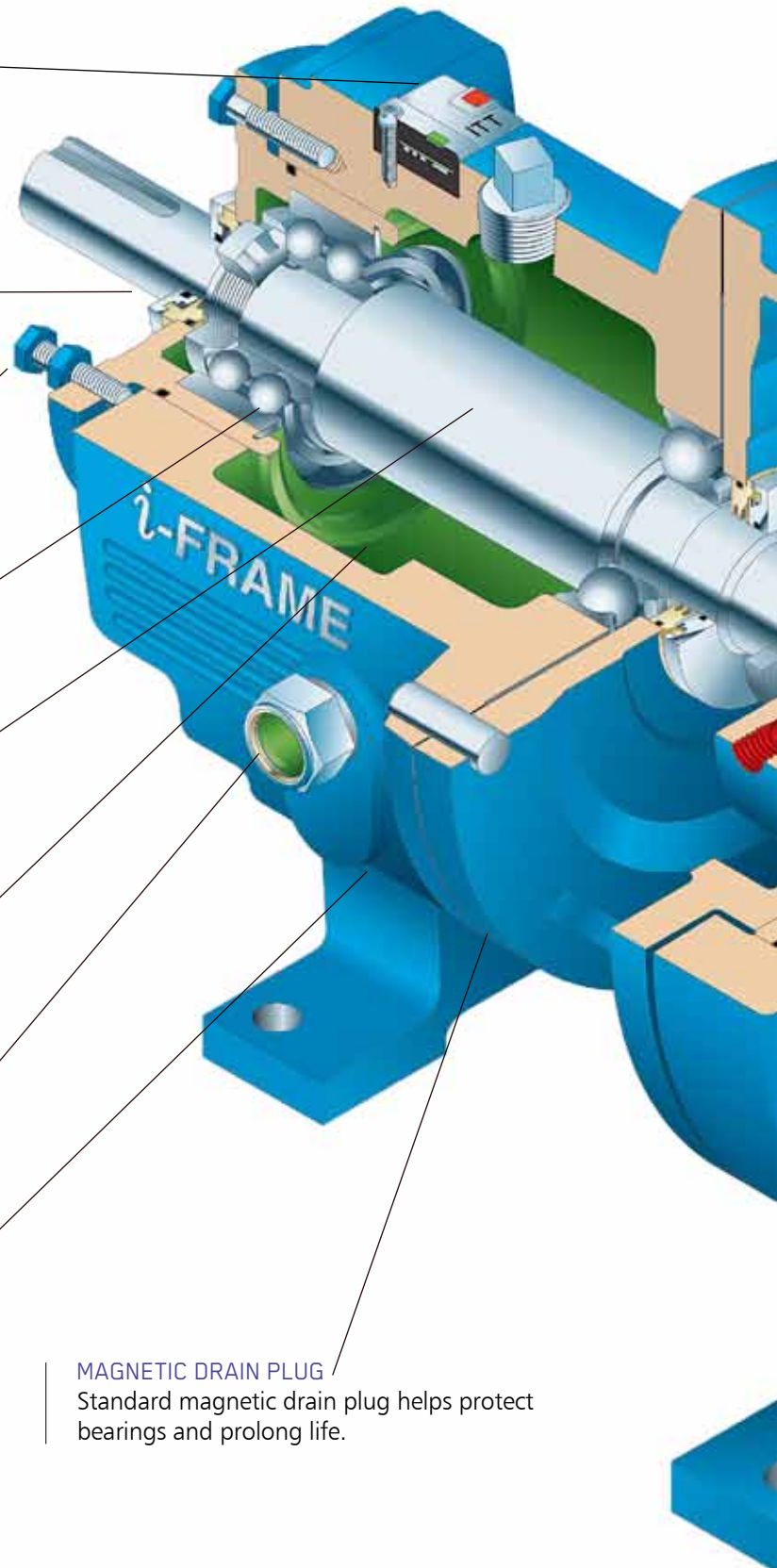



DUCTILE IRON FRAME ADAPTER
Material strength equal to carbon steel for safety and reliability.

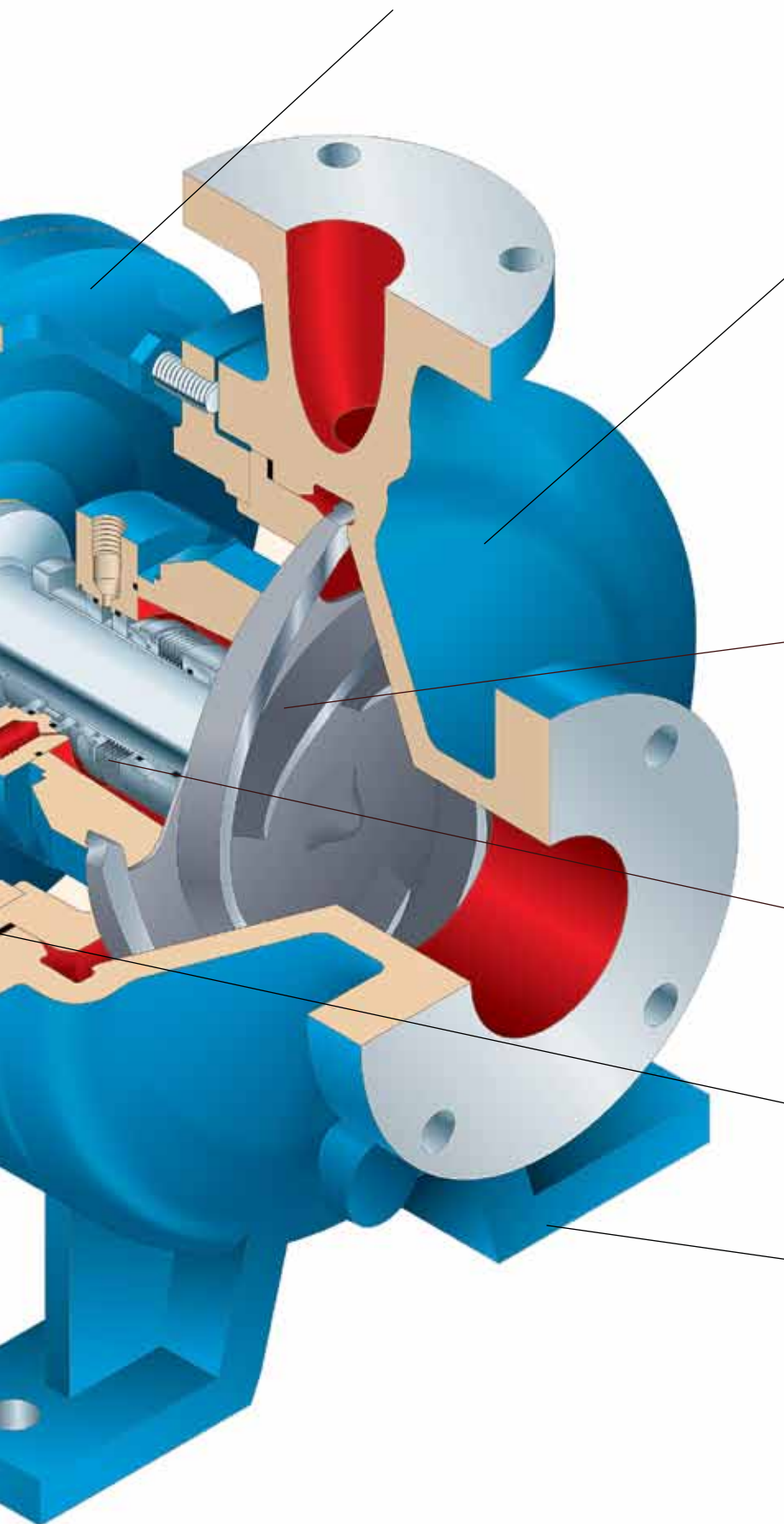

CASING

- Bonus casing thickness: Class 150 pumps feature Class 300 wall thickness as standard; increased reliability and maximized casing life.
- Top centerline discharge for air handling, self venting.
- Back pull-out design for ease of maintenance.
- Integral casing feet prevent pipe load misalignment – maximized seal and bearing life.
- Serrated flanges standard for positive sealing against leakage. Meets ANSI B16.5 requirements. Class 150 FF flanges standard, optional Class 150 RF, 300 FF/RF.

FULLY OPEN IMPELLER

Acknowledged best design for CPI services – solids handling, stringy material, corrosives, abrasives. Two times the wear area of closed-type impellers for longer life. Back pump-out vanes reduce radial thrust loads and seal chamber pressure.

SEALING FLEXIBILITY

Wide range of sealing arrangements available to meet service conditions. Engineered seal chambers improve lubrication and heat removal (cooling) of seal faces for extended seal life and pump uptime.

POSITIVE SEALING







Fully confined gasket at casing joint protects alignment fit from liquid, makes disassembly easier.

RIGID FRAME (AND CASING) FEET

Reduce effects of pipe loads on shaft alignment; pump vibration reduced.

Baseplate Mounting Systems

Goolds offers a complete range of pump mounting systems to meet plant requirements; make installation and maintenance easier.

Baseplate Selection Guide						
	CAMBER TOP CAST IRON Preferred standard of process industries. Rigid and corrosion resistant. It is the best value in the industry today.	CHEMBASE PLUS™ Polymer concrete construction provides exceptional rigidity & corrosion resistance. ANSI 1991 dimensional.	FABRICATED STEEL An economical choice that meets ANSI/ASME B73.1 dimensional requirements.	ENHANCED FEATURE FABRICATED STEEL Upgraded ANSI baseplate designed to maximize pump operation life and ease installation. Meets API-minded chemical pump users' toughest requirements.	ADVANTAGE Heavy duty PIP compliant fabricated steel baseplate.	POLYSHIELD ANSI COMBO Heavy duty polymer concrete combination baseplate and foundation.
PLANT REQUIREMENTS						
Corrosion Resistance (mild/moderate)	STANDARD	STANDARD	STANDARD	STANDARD	STANDARD	STANDARD
Corrosion Resistance (severe)	OPTIONAL	STANDARD	STANDARD	STANDARD	STANDARD	STANDARD
Machined Pump & Motor Parts	OPTIONAL	OPTIONAL	OPTIONAL	OPTIONAL	OPTIONAL	OPTIONAL
Circular Grout Holes (4 in. min.)	OPTIONAL	OPTIONAL	OPTIONAL	OPTIONAL	OPTIONAL	OPTIONAL
Vent Holes (1 in. min.)	OPTIONAL	OPTIONAL	OPTIONAL	OPTIONAL	OPTIONAL	OPTIONAL
Vent Holes (1/2 in. min.)	OPTIONAL	OPTIONAL	OPTIONAL	OPTIONAL	OPTIONAL	OPTIONAL
Non-Overhang	OPTIONAL	OPTIONAL	OPTIONAL	OPTIONAL	OPTIONAL	OPTIONAL
Full Drain Rim	OPTIONAL	OPTIONAL	OPTIONAL	OPTIONAL	OPTIONAL	OPTIONAL
Built-in Drain Pan (under pump)	OPTIONAL	OPTIONAL	OPTIONAL	OPTIONAL	OPTIONAL	OPTIONAL
Drain Pan Under Pump	OPTIONAL	OPTIONAL	OPTIONAL	OPTIONAL	OPTIONAL	OPTIONAL
Baseplate Leveling Screws	OPTIONAL	OPTIONAL	OPTIONAL	OPTIONAL	OPTIONAL	OPTIONAL
Motor Alignment Adjusters	OPTIONAL	OPTIONAL	OPTIONAL	OPTIONAL	OPTIONAL	OPTIONAL
Lifting Feature	OPTIONAL	OPTIONAL	OPTIONAL	OPTIONAL	OPTIONAL	OPTIONAL
Continuous Welding Used	OPTIONAL	OPTIONAL	OPTIONAL	OPTIONAL	OPTIONAL	OPTIONAL
Flexibly Mounted	OPTIONAL	OPTIONAL	OPTIONAL	OPTIONAL	OPTIONAL	OPTIONAL
Spring Loaded*	OPTIONAL	OPTIONAL	OPTIONAL	OPTIONAL	OPTIONAL	OPTIONAL
Available in 304 and 316 SS	OPTIONAL	OPTIONAL	OPTIONAL	OPTIONAL	OPTIONAL	OPTIONAL
ANSI B73.1-1991 Conformance	OPTIONAL	OPTIONAL	OPTIONAL	OPTIONAL	OPTIONAL	OPTIONAL
API-610 Conformance	OPTIONAL	OPTIONAL	OPTIONAL	OPTIONAL	OPTIONAL	OPTIONAL
PIP RESP.002 Conformance	OPTIONAL	OPTIONAL	OPTIONAL	OPTIONAL	OPTIONAL	OPTIONAL

STANDARD OPTIONAL *Engineered option—requires special baseplate

Bonus Interchangeability

i-FRAME™ Power Ends Fit 7 Different Process Pumps

Minimize inventory, reduce downtime.



3196 *i-FRAME*
Process Pumps



CV 3196 *i-FRAME*
Non-Clog
Process Pumps



HT 3196 *i-FRAME*
High Temperature
Process Pumps



LF 3196 *i-FRAME*
Low Flow ANSI
Process Pumps



3198 *i-FRAME*
PFA TEFLON®-Lined
Process Pumps



3796 *i-FRAME*
Self-Priming
Process Pumps



NM 3196 *i-FRAME*
Non-Metallic
Process Pumps

Options

Goulds offers users a variety of options to meet specific plant and process requirements.

Seal Flush Plans

All ANSI B73.1 seal flush and cooling plans are available to control emission levels and meet seal installation requirements of user preference.



CPI PLAN 7311
By-pass flush lubricates single seal faces.



CPI PLAN 7353
Pressurized circulation lubricates double seal faces.

High and Low Temperature Capability

Options are readily available for high and low temperature applications or where pumpage temperature must be controlled.

HEAT JACKET

Economical clamp-on jacket provides practical method of heating or cooling the casing. Excellent heat transfer characteristics. Easy to install or remove for pump servicing.



BEARING FRAME FINNED COOLER

Directly cools oil for lower bearing operating temperature. Requires minimum cooling water. Corrosion resistant construction. Recommended for temperatures over 350°F (177°C) when using conventional oil. When synthetic oil is used, pump can run up to 450°F without cooling. Above 450° add for high temperature option.



JACKETED SEAL CHAMBER

Maintains proper temperature control of sealing environment. Ideal for maintaining temperature for services such as molten sulphur and polymerizing liquids. Available in BigBore and patented TaperBore™ designs.



High Temperature Features

For operation to 700°F (371°C)

- Jacketed Stuffing Box/ Seal Chamber
- Finned Cooler
- 316 Stainless Steel Shaft
- Graphite-Impeller O-ring
- Graphite Casing Gasket



Part List and Materials of Construction

Item Number	Part Name	Material								
		Ductile Iron	316SS	CD4MCu	Alloy 20	Monel	Nickel	Hastelloy B & C	Titanium	
100	Casing	Ductile Iron	316SS	CD4MCu	Alloy 20	Monel	Nickel	Hastelloy	Titanium	
101	Impeller	Ductile Iron	316SS	CD4MCu	Alloy 20	Monel	Nickel	Hastelloy	Titanium	
105	Lantern Ring	Glass-Filled TEFLON*								
106	Stuffing Box Packing	TEFLON* Impregnated Fibers								
108	Frame Adapter	Ductile Iron								
112A	Thrust Bearing	Double Row Angular Contact**								
122	Shaft—Less Sleeve (Optional)	316SS			Alloy 20	Monel	Nickel	Hastelloy	Titanium	
122	Shaft—With Sleeve	SAE4140				316SS				
126	Shaft Sleeve	316SS		Alloy 20		Monel	Nickel	Hastelloy	Titanium	
136	Bearing Locknut and Lockwasher	Steel								
168A	Radial Bearing	Single Row Deep Groove								
184	Stuffing Box Cover (Packed Box)	Ductile Iron	316SS	CD4MCu	Alloy 20	Monel	Nickel	Hastelloy	Titanium	
184	Seal Chamber (Mechanical Seal)	Ductile Iron	316SS	CD4MCu	Alloy 20	Monel	Nickel	Hastelloy	Titanium	
228	Bearing Frame	Cast Iron (Ductile Iron for STi Group)								
250	Gland	316SS		Alloy 20		Monel	Nickel	Hastelloy	Titanium	
262	Repeller/Sleeve (Dynamic Seal Option)	CD4MCu			Alloy 20		Monel	Nickel	Hastelloy	Titanium
264	Gasket, Cover-to-Backplate (Dynamic Seal)	TEFLON*								
370H	Stud/Nut, Cover-to-Adapter	304SS								
319	Oil Sight Glass	Glass/Steel								
332A	INPRO® VB-XX-D Labyrinth Oil Seal (Outboard)	Stainless Steel/Bronze								
333A	INPRO® VB-XX-D Labyrinth Oil Seal (Inboard)	Stainless Steel/Bronze								
351	Casing Gasket	Aramid Fiber with EPDM Rubber								
358	Casing Drain Plug (Optional)	Steel	316SS	Alloy 20		Monel	Nickel	Hastelloy	Titanium	
360F	Gasket, Frame-to-Adapter	Buna								
360C	Gasket, Bearing End Cover	Cellulose Fiber with Binder								
370	Cap Screw, Adapter-to-Casing	Steel								
412A	O-ring, Impeller	Glass-Filled TEFLON*								
418	Jacking Bolt	304SS								
444	Backplate (Dynamic Seal Option)	Ductile Iron	316SS	CD4MCu	Alloy 20	Monel	Nickel	Hastelloy	Titanium	
469B	Dowel Pin, Frame-to-Adapter	Steel								
496	O-ring, Bearing Housing	Buna Rubber								
761B	i-ALERT Condition Monitor	Stainless Steel/Epoxy								

*E.I. DuPont reg. trademark

**LTi Power End features standard Duplex Angular Contact; Optional STi, MTi, XLTi

Other Alloys Available: 316L, 317, 317L, 254SMO, Zirconium, etc.

Sectional View 3196 *i-FRAME*™

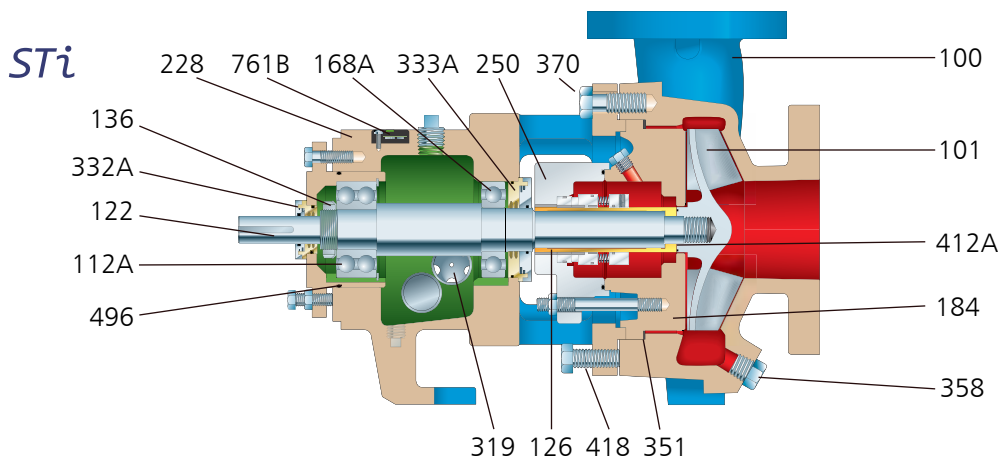

Sectional View

MTi / LTi

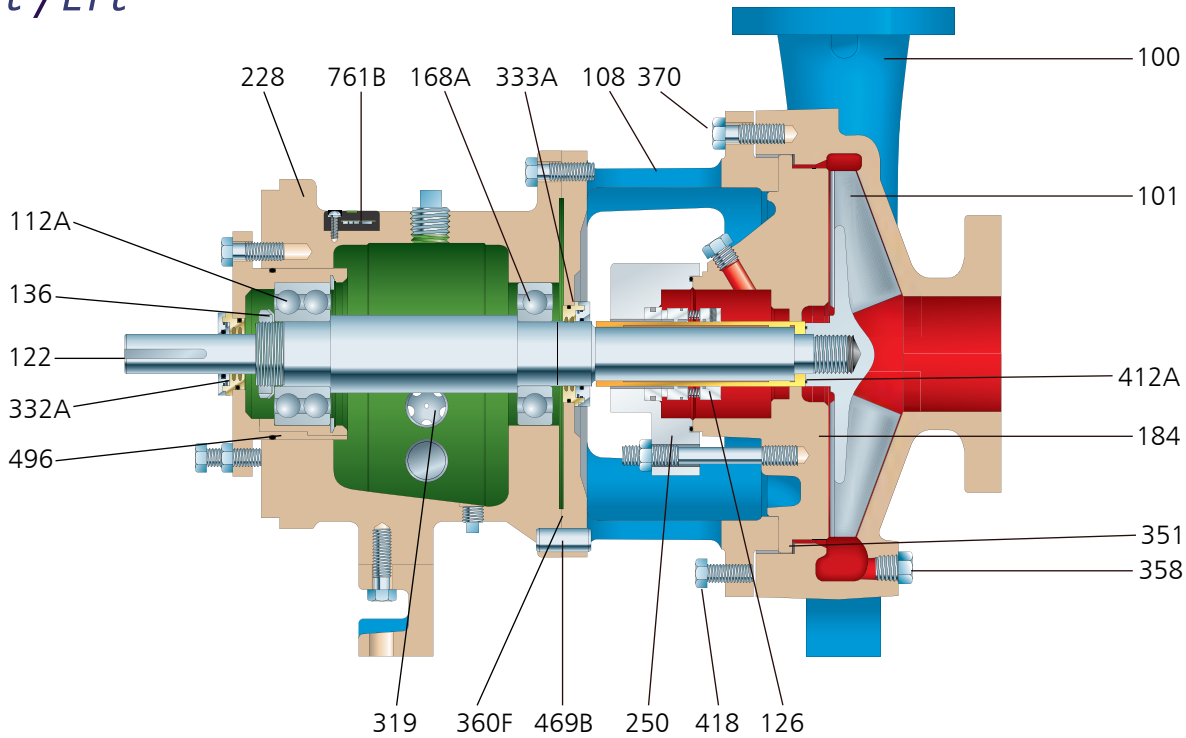

XLTi

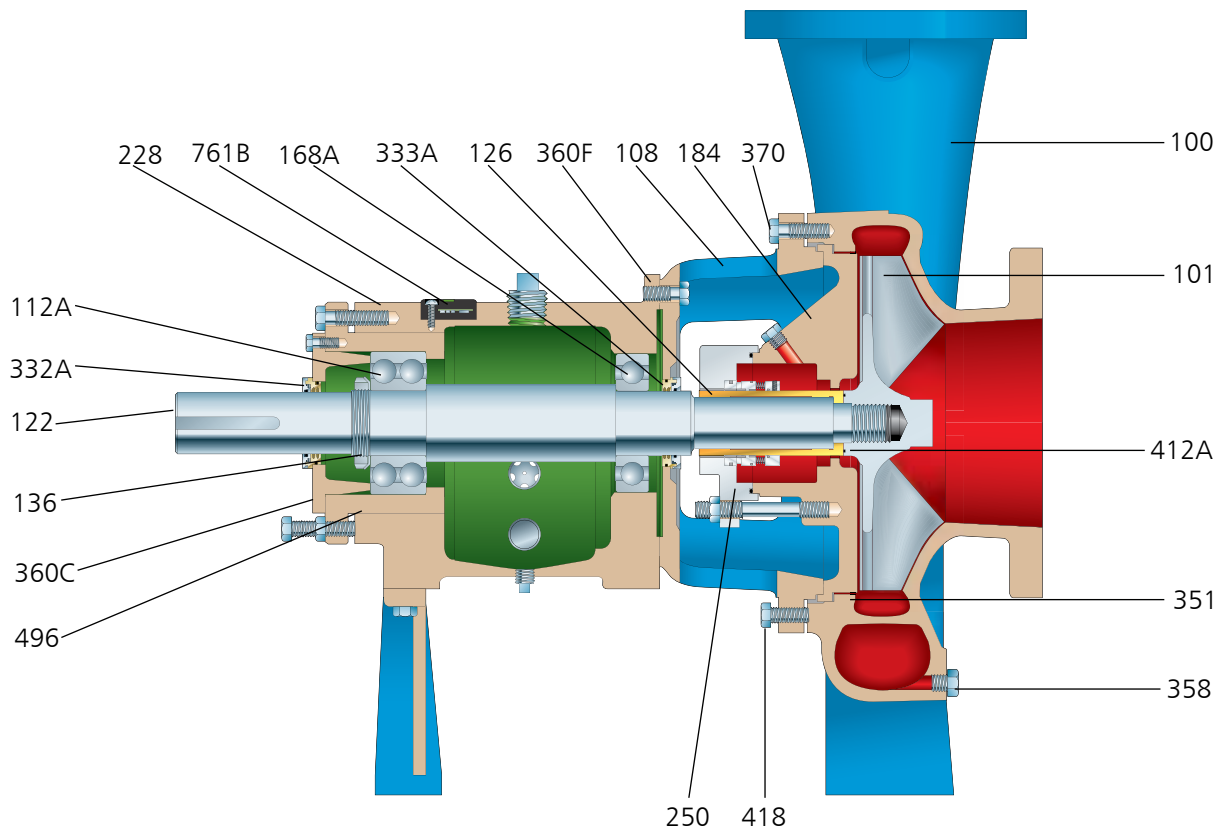

Hydraulic Coverage

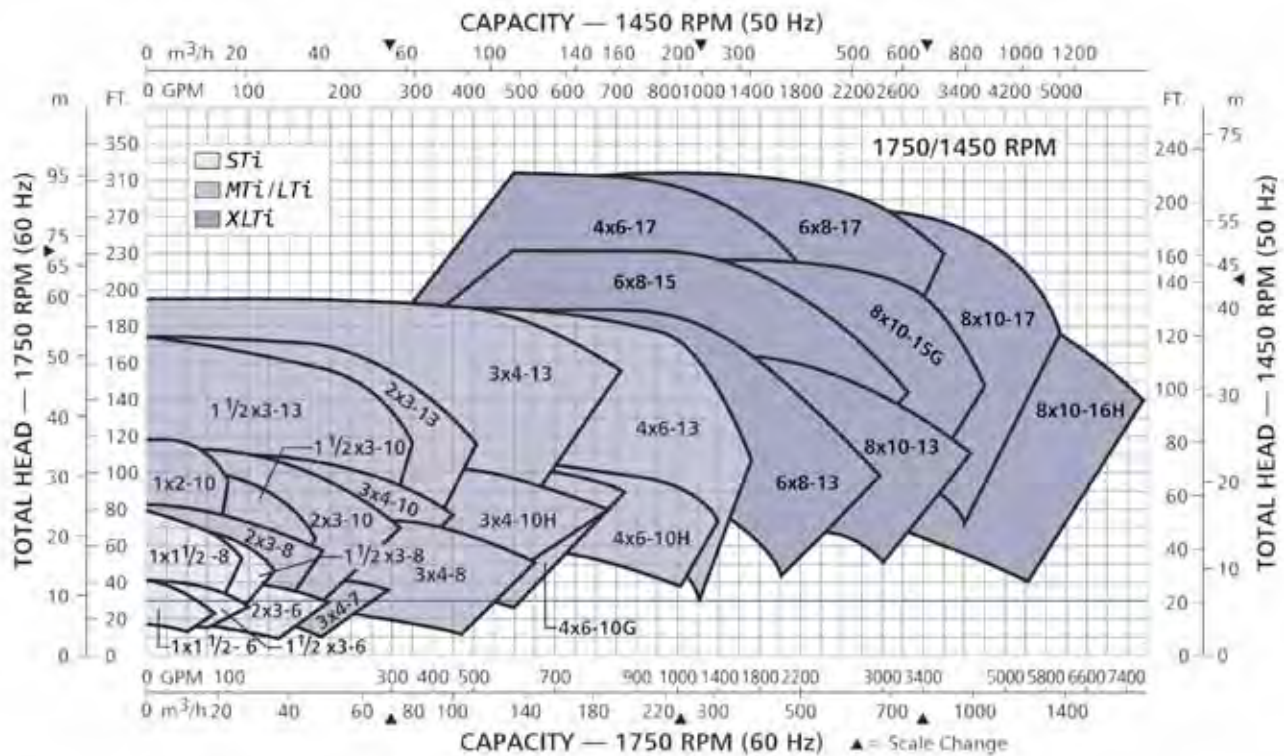
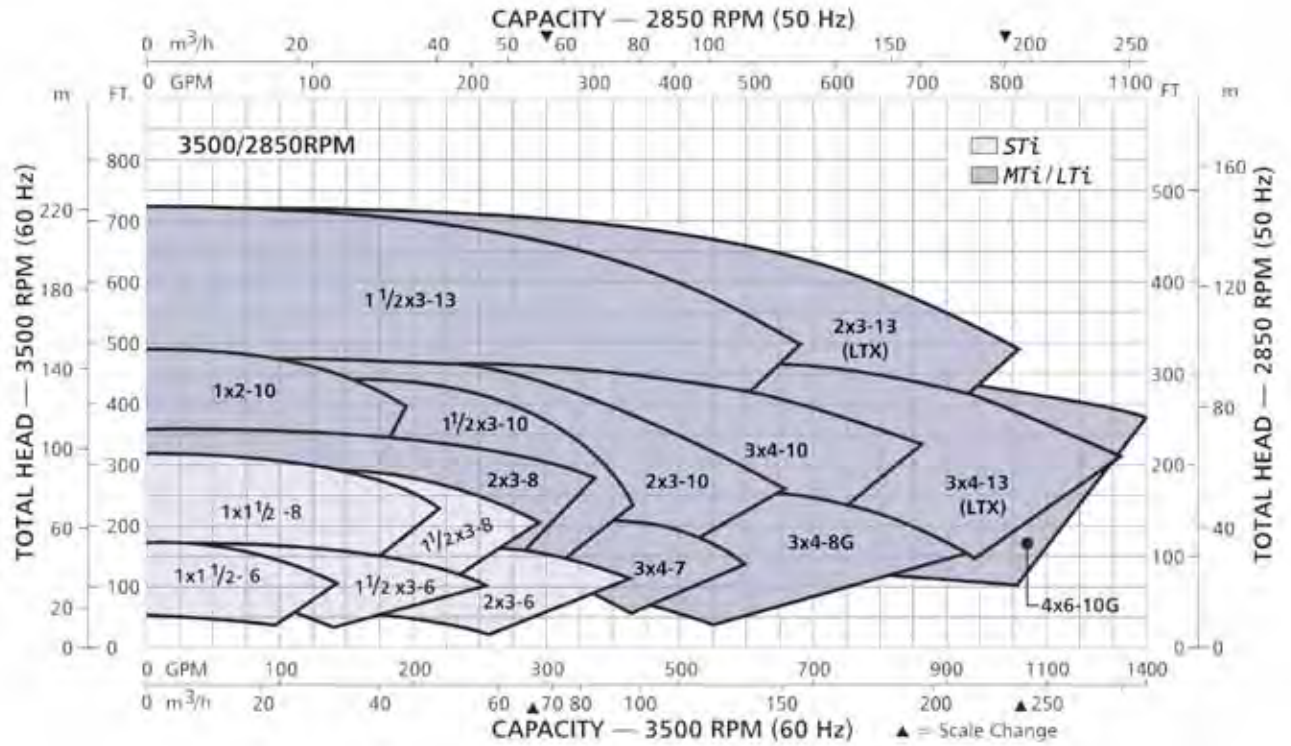

Dimensions

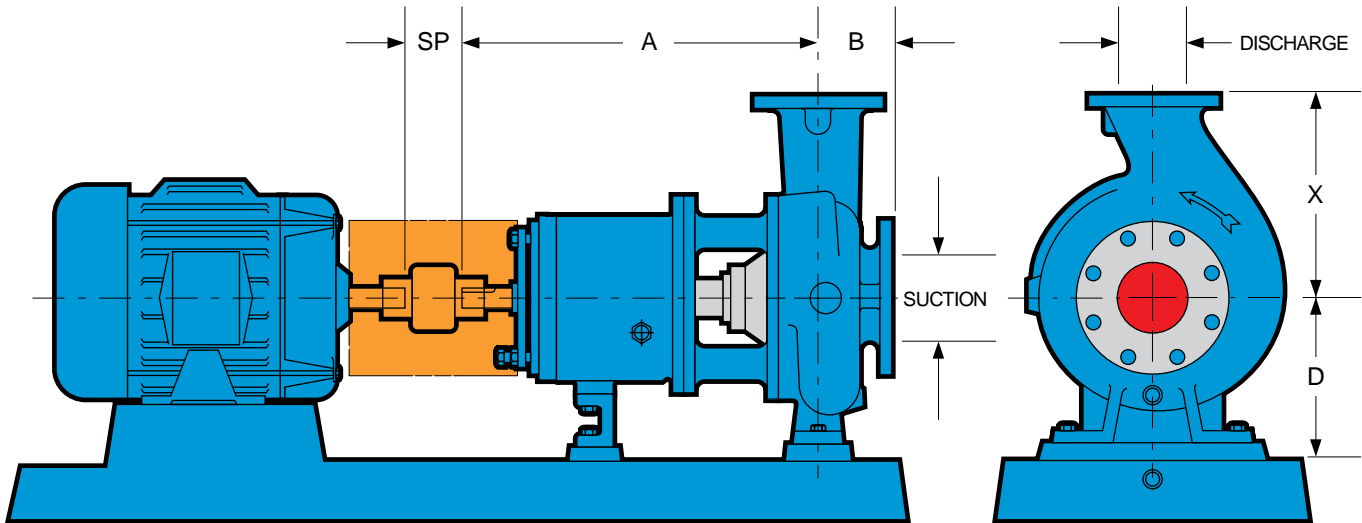

DIMENSIONS														
Group	Pump Size	ANSI Designation	Discharge Size	Suction Size	X	A	B	D	SP	Bare Pump Weight Lbs. (kg)				
STi	1x1½-6	AA	1	1½	6.5 (165)	13.5 (343)	4 (102)	5.25 (133)	3.75 (95)	84 (38)				
	1½x3-6	AB	1½	3						92 (42)				
	2x3-6	AC	2	3						95 (43)				
	1x1½-8	AA	1	1½						100 (45)				
	1½x3-8	AB	1½	3						108 (49)				
MTi / LTi	3x4-7	A70	3	4	11 (280)	19.5 (495)	4 (102)	8.25 (210)	3.75 (95)	220 (100)				
	2x3-8	A60	2	3	9.5 (242)					220 (91)				
	3x4-8	A70	3	4	11 (280)					220 (100)				
	3x4-8G	A70	3	4	11 (280)					220 (100)				
	1x2-10	A05	1	2	8.5 (216)					200 (91)				
	1½x3-10	A50	1½	3	9.5 (242)					220 (100)				
	2x3-10	A60	2	3	9.5 (242)					230 (104)				
	3x4-10	A70	3	4	11 (280)					265 (120)				
	3x4-10H	A40	3	4	12.5 (318)					275 (125)				
	4x6-10G	A80	4	6	13.5 (343)					305 (138)				
	4x6-10H	A80	4	6	13.5 (343)					305 (138)				
	1½x3-13	A20	1½	3	10.5 (267)					19.5 (495)	4 (102)	10 (254)	3.75 (95)	245 (111)
	2x3-13	A30	2	3	11.5 (292)									275 (125)
	3x4-13	A40	3	4	12.5 (318)									330 (150)
4x6-13	A80	4	6	13.5 (343)	405 (184)									
XLTi	6x8-13	A90	6	8	16 (406)	27.875 (708)	6 (152)	14.5 (368)	5.25 (133)	560 (254)				
	8x10-13	A100	8	10	18 (457)					670 (304)				
	6x8-15	A110	6	8	18 (457)					610 (277)				
	6x8-15N	A110	6	8	18 (457)					610 (277)				
	8x10-15	A120	8	10	19 (483)					740 (336)				
	8x10-15G	A120	8	10	19 (483)					710 (322)				
	8x10-16H	A120	8	10	19 (483)					850 (385)				
	4x6-17	A105	4	6	16 (406)					650 (295)				
	6x8-17	A110	6	8	18 (457)					730 (331)				
	8x10-17	A120	8	10	19 (483)					830 (376)				

All dimensions in inches and (mm). Not to be used for construction.

Construction Details

		STi	MTi	LTi	XLTi
Shaft	Diameter at Impeller	.75 (19)	1 (25)	1.25 (32)	1.5 (38)
	Diameter in Stuffing Box/Seal Chamber (Less Sleeve)	1.375 (35)	1.75 (45)	2.125 (54)	2.5 (64)
		(With Sleeve)	1.125 (29)	1.5 (38)	1.875 (48)
	Diameter Between Bearings	1.5 (38)	2.125 (54)	2.5 (64)	3.125 (79)
	Diameter at Coupling	.875 (22)	1.125 (29)	1.875 (48)	2.375 (60)
	Overhang	6.125 (156)	8.375 (213)	8.375 (213)	9.969 (253)
	Maximum Shaft Deflection	0.002 (0.05)			
	Shaft Deflection Index (L^3/D^4) (With Sleeve)	143	116	48	62
(Less Sleeve)		64	63	29	25
Sleeve	O.D. thru Stuffing Box/Seal Chamber	1.375 (35)	1.75 (45)	2.125 (54)	2.5 (64)*
Bearings	Radial	6207	6309	6311	6313
	Thrust	3306	3309	7310	3316
	Bearing Span	4.125 (105)	6.75 (171)	6.875 (164)	9.25 (235)
BigBore™ Seal Chamber	Bore	2.875 (73)	3.5 (89)	3.875 (98)	4.75 (120)*
Stuffing Box	Bore	2 (51)	2.5 (64)	2.875 (73)	3.375 (86)*
Power Limits	HP (kW) per 100 RPM	1.1 (.82)	3.4 (2.6)	5.6 (4.2)	14 (10.5)**
Temperature	Maximum Liquid Temperature— Oil/Grease Lubrication without Cooling	350° F (177° C)			
	Maximum Liquid Temperature— Oil Lubrication with High Temp. Option	700° F (370° C)			
Casing	Corrosion Allowance	.125 (3)			

* 17 inch sizes have 2 1/8 inch (57) shaft diameters in stuffing box/seal chamber with sleeve. Shaft sleeve O.D. is 2 1/8 inches (70) for packing and 2 1/8 inches (64) for mechanical seals. Seal chamber bore is 4 1/8 inches (121). Stuffing box bore is 3 1/8 inches (92).

** 17 inch sizes power limit per 100 RPM is 20HP (15kW).

Process Industry Practices (PIP) Compliance

The standard design features of Goulds 3196 (ANSI B73.1M) and 3996 (ANSI B73.2M) pumps meet ASME/ANSI standards. In addition, both models can be manufactured to comply with PIP Specifications for application of horizontal and vertical in-line ANSI process pumps.



Model 3196 meets B73.1M and RESP73H



Model 3996 meets B73.2M and RESP73H

Other Features For Safety & Reliability

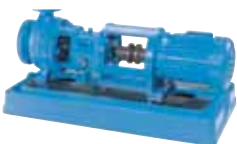

C-FACE ADAPTER
i-FRAME power ends accommodate optional C-face motor adapter – simplifies pump/motor alignment.



3196CC (Close Coupled)
Certain sizes of the 3196 are available in a close coupled configuration which saves space, requires less maintenance and needs no alignment.



CENTERLINES-MOUNTED CASING
For high temperature services (500° to 700° F/260° to 370° C).



ANSI COUPLING GUARD
Meets all requirements of ANSI B15.1 specifications.



SHAFT GUARD
When a guard around all rotating shaft parts is required.

Visit our website at
www.gouldspumps.com

Wherever you are, we're there too.

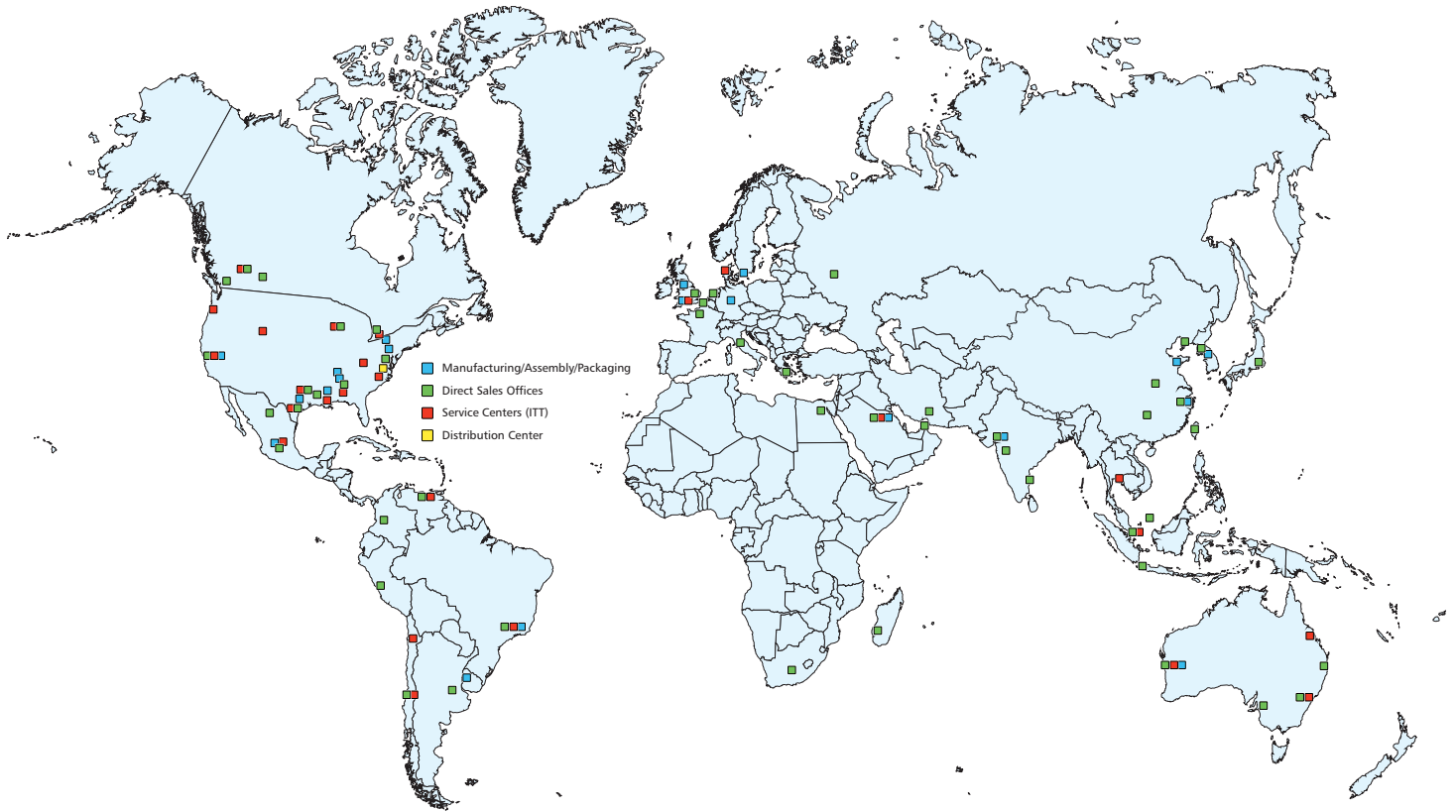

Reliability has no quitting time.

Building on over 160 years of Goulds Pumps experience, PRO Services provides an array of services focused on reducing equipment total cost of ownership (TCO) and increasing plant output, including predictive monitoring, maintenance contracts, field service, engineered upgrades, inventory management, and overhauls for pumps and other rotating equipment.

Your Total Solution For Equipment Life Cycle Optimization

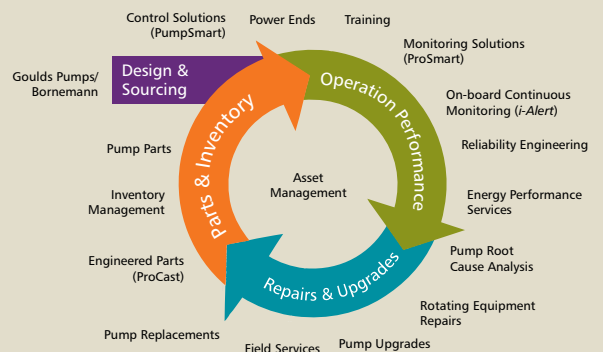

240 Fall Street
Seneca Falls, NY 13148
www.itt.com

© 2014 ITT Corporation, Inc.

Form B3196i-FRAME 07/14